

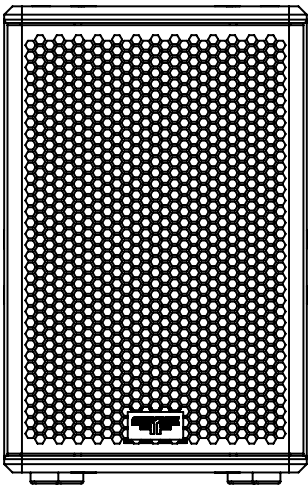

# VENU SERIES

USER MANUAL • Version 2.0 (English)



**VENU 8**

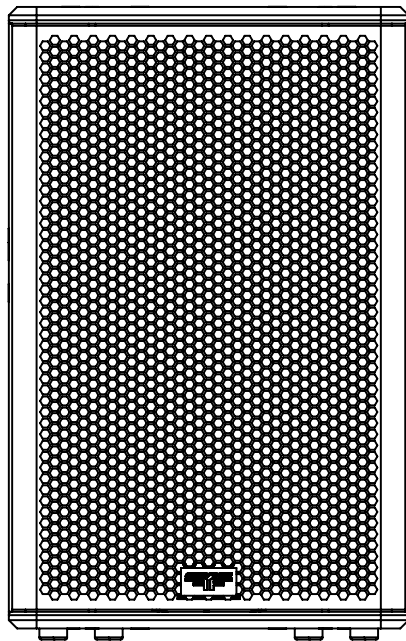

**VENU 12**

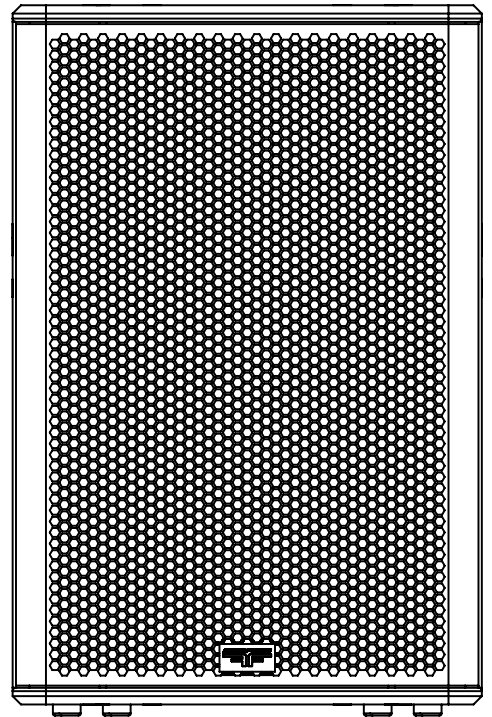

**VENU 15**





**If you could only choose one loudspeaker...**

# SUMMARY

---

1. Summary .....	3
2. Manufacturer Declarations .....	4-6
2.1 Safety Standards	4
2.2 Operation	5
2.3 Sound levels	6
3. System Description .....	6-13
3.1 Introduction	6
3.2 VENU series range	7
3.2.1 VENU 8	7
3.2.2 VENU 12	8
3.2.3 VENU 15	9
3.3 Additional Low End	10
3.3.1 S 15 / S 18	10
3.3.2 MTSub 218	11
3.3.3 S 21	12
3.4 Accessories	13
4. Self-powered (A) version setup .....	15-17
4.1 Connections	15
4.2 User interface	16-17
5. Bi-amp & X- version setup .....	18-22
5.1 Amplifier configuration	18
5.2 Connections	21
5.3 Preset handling	22
6. User guidelines .....	23-26
6.1 Stacking and rigging	23
6.3 Maintenance	26
7. Technical specifications .....	28-33
8. Contact and links .....	34

## 2. MANUFACTURER DECLARATIONS

---

### 2.1 Safety standards

**AUDIOFOCUS® is a Trademark of COMMUNITY EUROPE S.A**

Rue du Polissou, 17  
B-5590 Achêne  
Belgium

Community Europe S.A is in conformity with the provisions of the following EC Directives, including all amendments, and with national legislation implementing these directives:

- 2014/35/EU
- 2014/30/EU

Voltage regulations.

Electromagnetic Compatibility Directive RoHs Directive

The following harmonized standards are applied:

- EN 55103-1:2009,
- EN 55103-1:2009/A1:2012
- EN 55103-2:2009
- EN 61000-3-2:2014
- EN 61000-3-3:2013
- EN 61000-3-11:2000
- EN 62368-1:2014
- EN 62368-1:2014/AC:2015

Specified characteristics are measured and given the following standard:

- EN 60268-5

Speakers, rigging and accessories follow Machinery Directive:

- 2006/42/CE with a static test coefficient of 7.

**This manual is intended for information purposes only, is subject to change without notice, and cannot be used as a commitment by Community Europe S.A.**

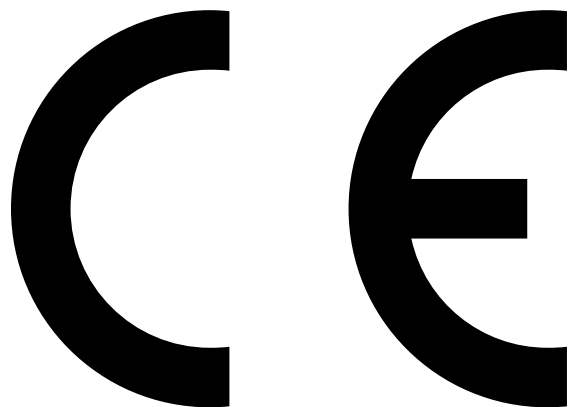



## 2.2 Operation

**Important safety instructions are indicated by the following symbol to attract your attention:**



- Read and keep these instructions.
- Follow this manual and its instructions.
- Keep the device away from water and moisture.
- Keep the device away from heat sources of any kind.
- Only use accessories which have been tested and approved by AUDIOFOCUS.
- Pay attention to the correct application and maximum load capacity of the accessories as detailed in our specific “Mounting instructions” or in our “Flying system and rigging manuals”.
- Ensure that all additional hardware, fixings and fasteners used for installation or mobile deployment are of an appropriate size and load safety factor.
- Pay attention to the manufacturers’ instructions and to the relevant safety guidelines.
- Regularly check the loudspeaker condition and accessories for visible signs of wear and tear, and replace them when necessary.
- Regularly check all load bearing bolts in the mounting devices.
- Powered devices must be electrically grounded and connected through a circuit breaker and residual current circuit breaker. National or local electrical standards (such as IEC) should be respected.

**Tips that could help you use the speaker more efficiently are indicated by a tip symbol:**



**External usage temperature should be between 0°C and 45°C. Humidity should be 90% non-condensing maximum. Storage temperature -20°C to 70°C.**

## 2.3 Sound levels



**VENU series loudspeakers can deliver high sound pressure levels that could permanently damage the hearing of production crew, artists and audience members. Do not stay in close proximity to loudspeakers when in use. Check and obey all applicable laws and regulations regarding maximum sound levels and length of exposure.**

## 3. SYSTEM DESCRIPTION

---

### 3.1 Introduction

Thank you for choosing an AUDIOFOCUS VENU Series full range 2 way point source speaker.

This user manual contains essential information for deploying VENU 8, VENU 12 or VENU 15 elements to their full capability. Read this document carefully to become familiar with the system.

Whether you are using 2 elements or 24, as floor monitors, adjustable angle pole mounted or rigged, we are sure you will find the VENU to be a highly versatile addition to your professional sound reinforcement inventory or fixed installation.

Since point source loudspeakers cannot sum coherently in the way true line source arrays do (especially in the higher frequencies), they are best used in single box or small arrays that are focused on discrete listening areas to minimize comb filter effects.

All VENU series cabinets are made from Birch plywood for rock solid construction and are shaped in anisometric hexagonal designs to allow for use as stage monitors if necessary. They feature powder coated steel grills.

For precise aiming and control, and to ensure as little high frequency overlap as possible, all VENU 12 and VENU 15 loudspeakers are equipped with a rotatable wave guide.

To keep costs down in budget-conscious applications, AUDIOFOCUS offers the VENU series in active, bi-amp passive and single channel passive versions.\*

*\*VENU 8 is only offered in active or single channel passive versions.*

## 3.2 VENU SERIES RANGE

### 3.2.1 VENU 8 Series

VENU 8 is a versatile, full range, 2-way point source speaker with a great power to size ratio. VENU 8 fits a broad range of applications, such as small PA, monitors or distributed installation. It can be used on a pole as a FoH speaker or with an additional subwoofer, making it suitable for sound reinforcement applications spanning small scale concerts, public places or theaters where sound quality is crucial.

VENU 8 houses an 8" LF driver and a 1" HF exit driver with a conical 80° waveguide.

Fig.1

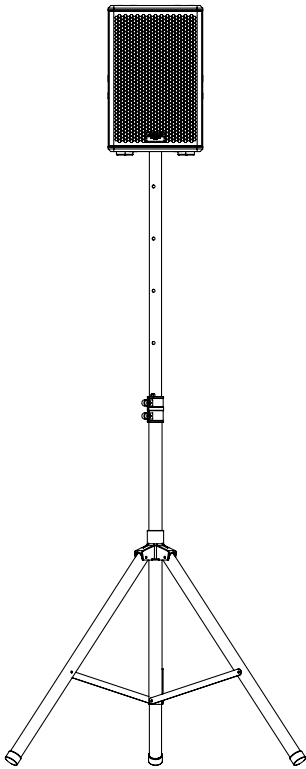

Fig.2

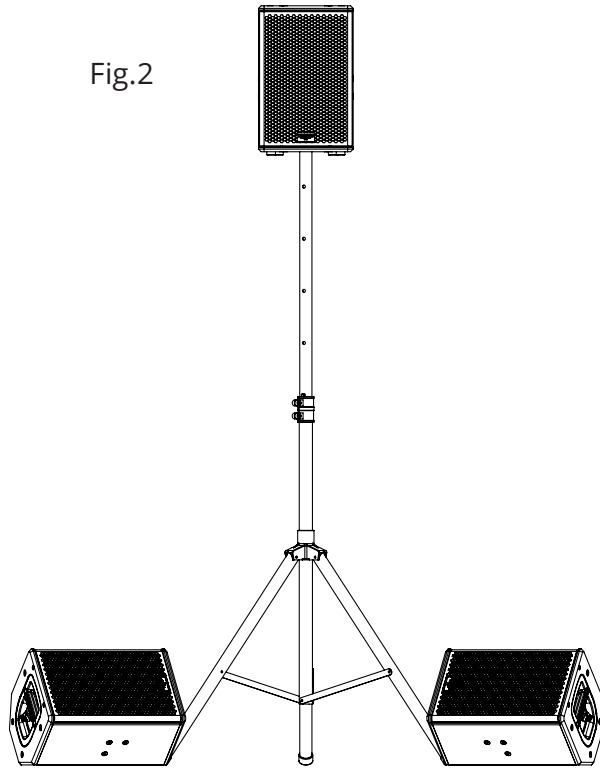
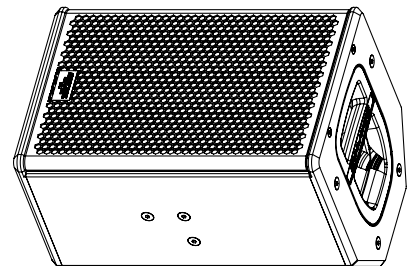
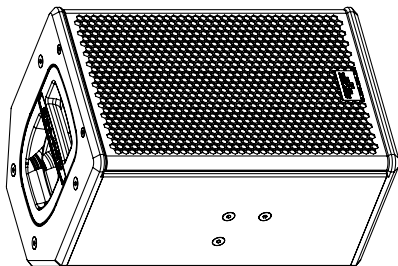

Fig.3



### 3.2.2 VENU 12 Series

VENU 12 is a versatile, full range, 2-way point source speaker. The VENU 12 is the workhorse of the series and can be used for many different applications due to its power to size performance, such as small PA, monitors or distributed installation. It can be used on a pole as a FoH speaker or with an additional subwoofer, making it suitable for applications spanning small scale concerts, public places or theaters where sound quality is crucial.

VENU 12 houses a 12" LF driver and a 1" HF driver mounted on a rotatable 110°x60° waveguide.

Fig.1

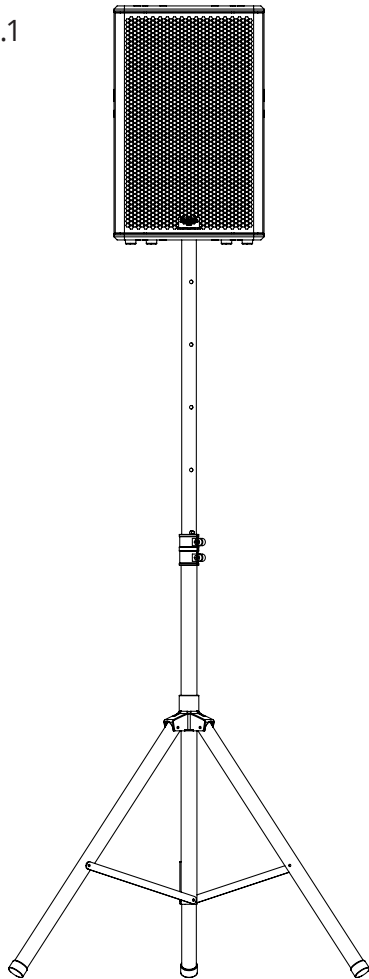

Fig.2

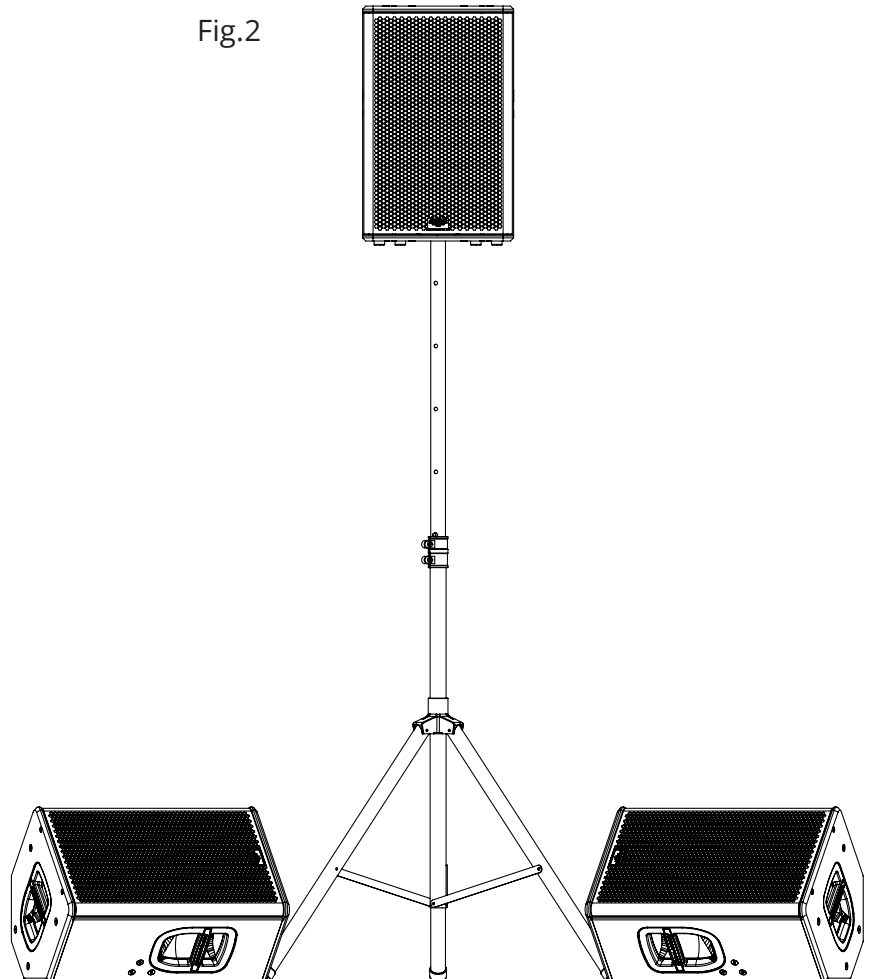

Fig.3



### 3.2.3 VENU 15 Series

VENU 15 is a versatile, full range 2-way point source speaker. It is the largest product of the series. VENU 15 fits a broad range of applications, such as medium PA, monitors or distributed installation. It can be used on a pole as a FoH speaker or with an additional subwoofer, making it suited to applications spanning small scale concerts, public places or theaters where sound quality is crucial.

VENU 15 houses a 15" LF driver and a 1" HF driver mounted on a rotatable 110°x60° waveguide.

Fig.1

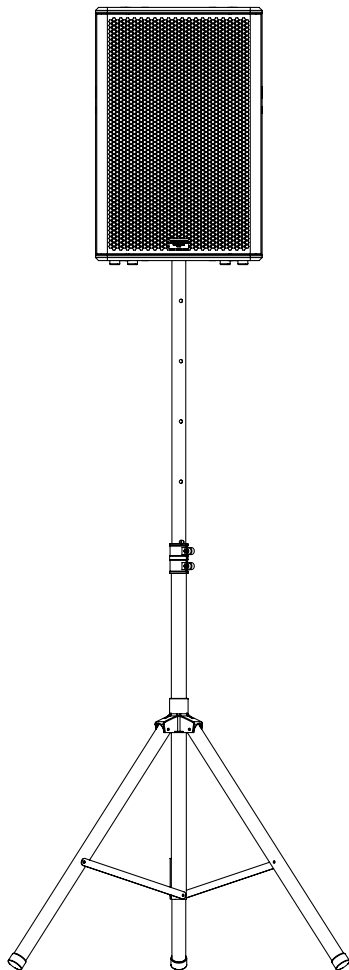

Fig.2

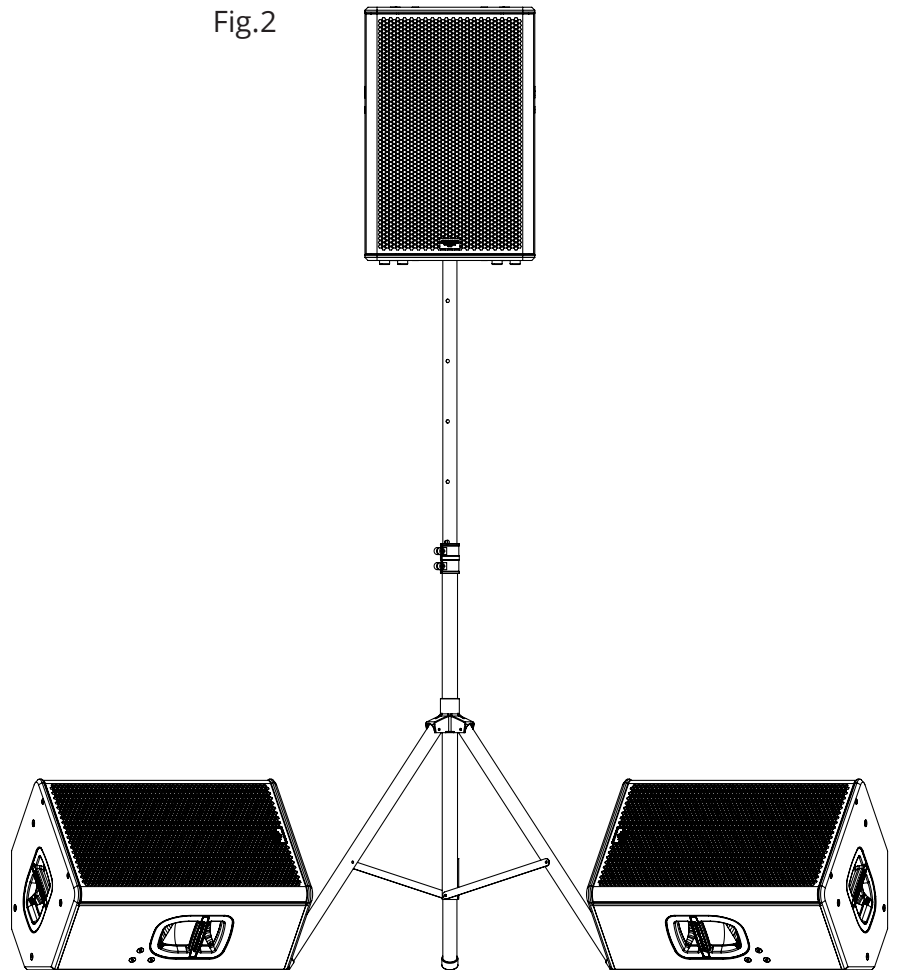

Fig.3



## 3.3 Additional Low End

### 3.3.1 S 15 and S 18

VENU series speakers can be used with the S 15 or S 18 subwoofer, pole mounted.\*

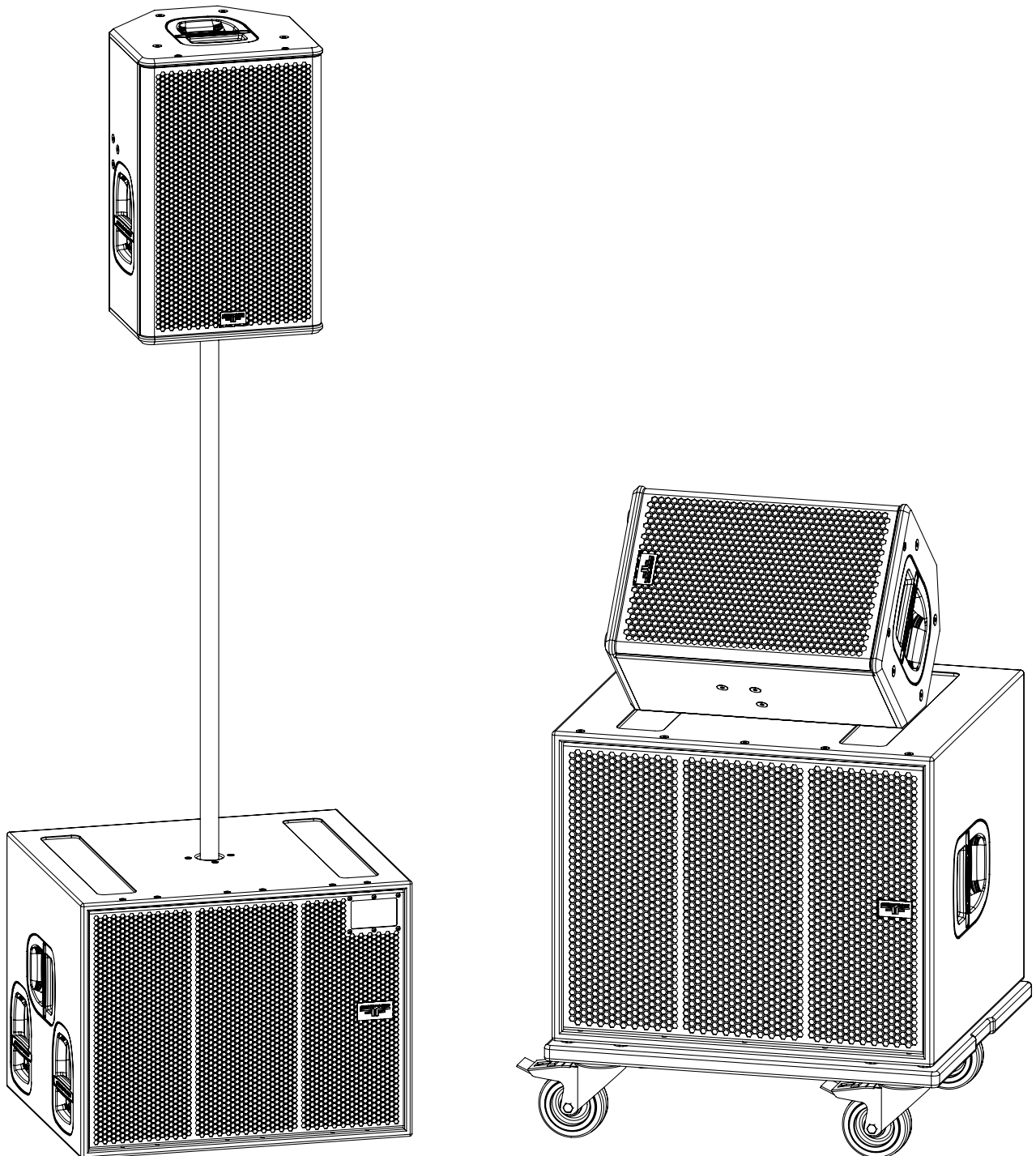

### 3.3.2 MTSub 218

VENU series speakers can be used with the MTSub 218 subwoofer.\*

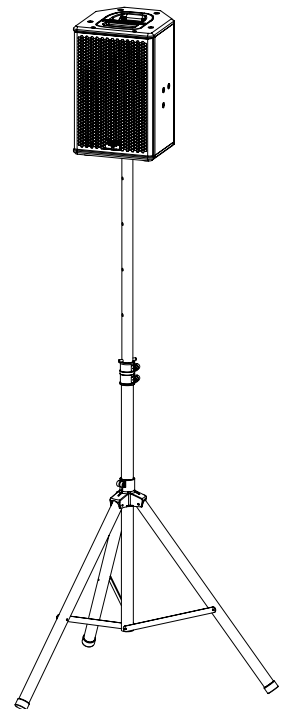
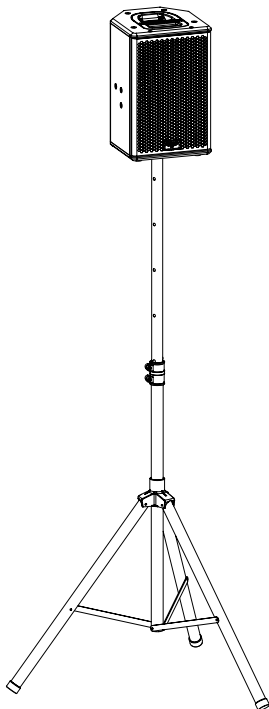
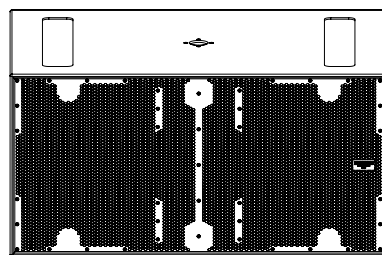
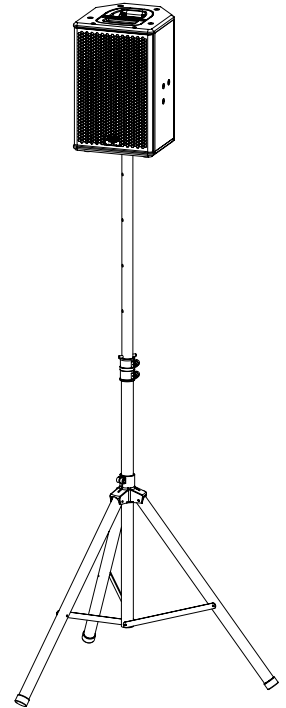
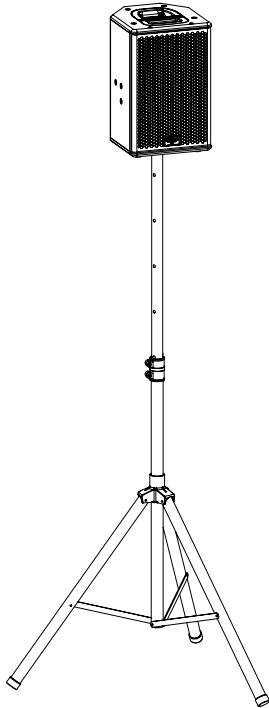



### 3.3.3 S 21

VENU series speakers can be used with the S 21 subwoofer.\*

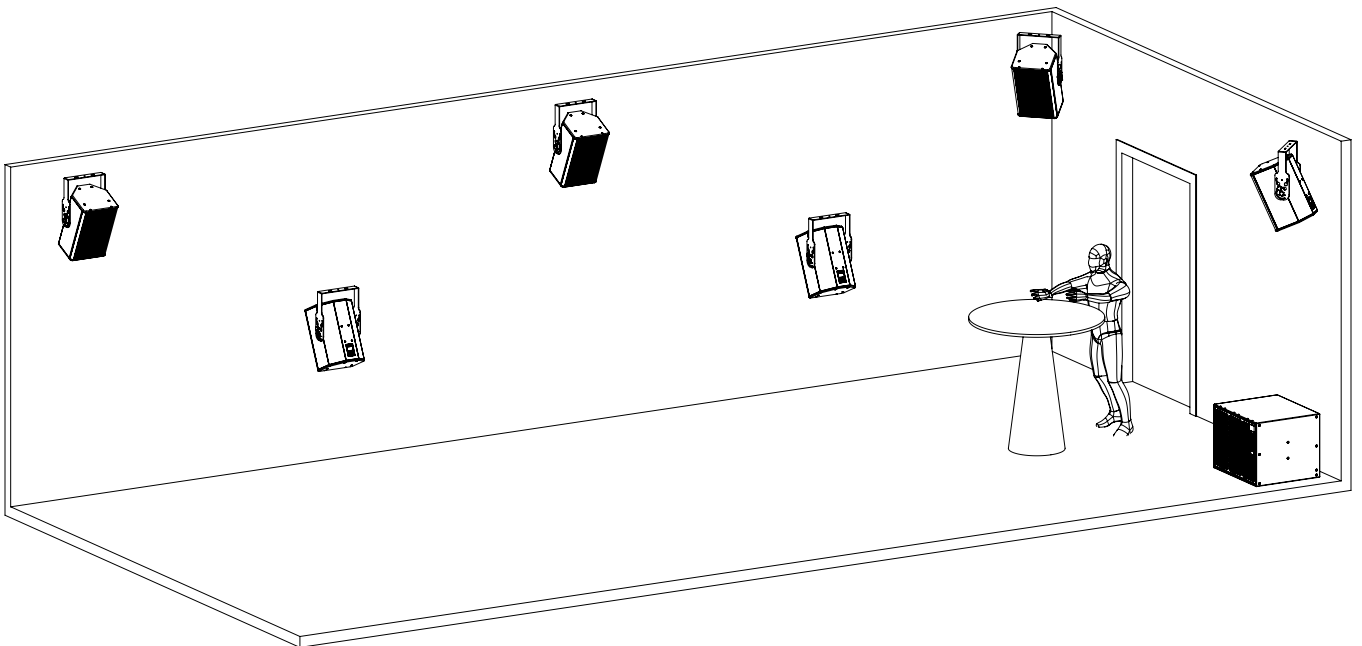



*\* Note: for easy and accurate set up, all Venu series speakers are time and phase aligned to the sub series when fronts are aligned in a stacked configuration using Audiofocus presets.*

## 3.4 Accessories

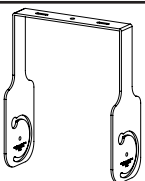
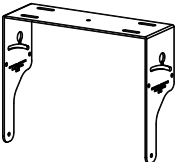

The official VENU rain cover will protect the speaker from rain and direct sun radiation without affecting the sound quality of the unit

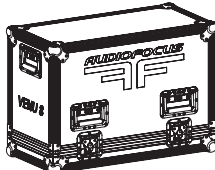
ACCESSORIES	NAME PRODUCT CODE	WEIGHT	
	<b>Vertical Yoke for VENU</b> Ref. : 47100 (VENU 8) Ref. : 47102 (VENU 12) Ref. : 47103 (VENU 15)	5 Kg	
	<b>Horizontal Yoke for VENU</b> Ref. : 47820 (VENU 8) Ref. : 47822 (VENU 12) Ref. : 47823 (VENU 15)	6 Kg	
	<b>Rain Cover for VENU</b> Ref. : 47108 (VENU 8) Ref. : 47111 (VENU 12) Ref. : 47110 (VENU 15)	0.3 Kg	
	<b>Protection Cover for VENU</b> Ref. : 47299 (VENU 8) Ref. : 47301 (VENU 12) Ref. : 47302 (VENU 15)	0.2 Kg	
	<b>Touring flightcases for VENU</b> Ref.: 47112 Flightcase for 2 VENU 8(a) without wheels Ref.: 47114 Touring Flightcase for 2 VENU 12(a) incl. wheels Ref.: 47115 Touring Flightcase for 2 VENU 15(a) incl. wheels		

Official VENU series flight cases protect your investment and can prolong speaker life.

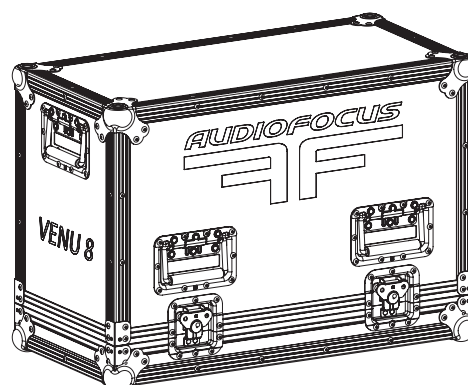



## 4. SELF-POWERED (A) VERSION SETUP

---

### 4.1 Connections

AUDIOFOCUS power and audio cables with the appropriate diameter, length and connectors are recommended. OPERATING VOLTAGE must always stand between 90 and 264V. The power supply will auto switch between 110V or 230V, allowing the device to be used internationally without additional settings.



**AC POWER DISTRIBUTION must be properly grounded and on the same network for the entire sound system. Bad grounding could result in unwanted noise and security issues for users and audience.**

#### PowerCON True 1 TOP Connection

Each VENU module has two powerCON TRUE1 TOP connectors. Each link cable must be able to manage the whole linked system and its diameter will then follow this total power need.



**Always consider a 500W, @ 230V power rating power when calculating the maximum possible number of devices to be linked.**



**A maximum of 8 VENU speakers can be linked thru the powerCON TRUE1 connector on a 230V 20A mono line with a 2.5mm<sup>2</sup> diameter. AUDIOFOCUS originals cables are recommended.**



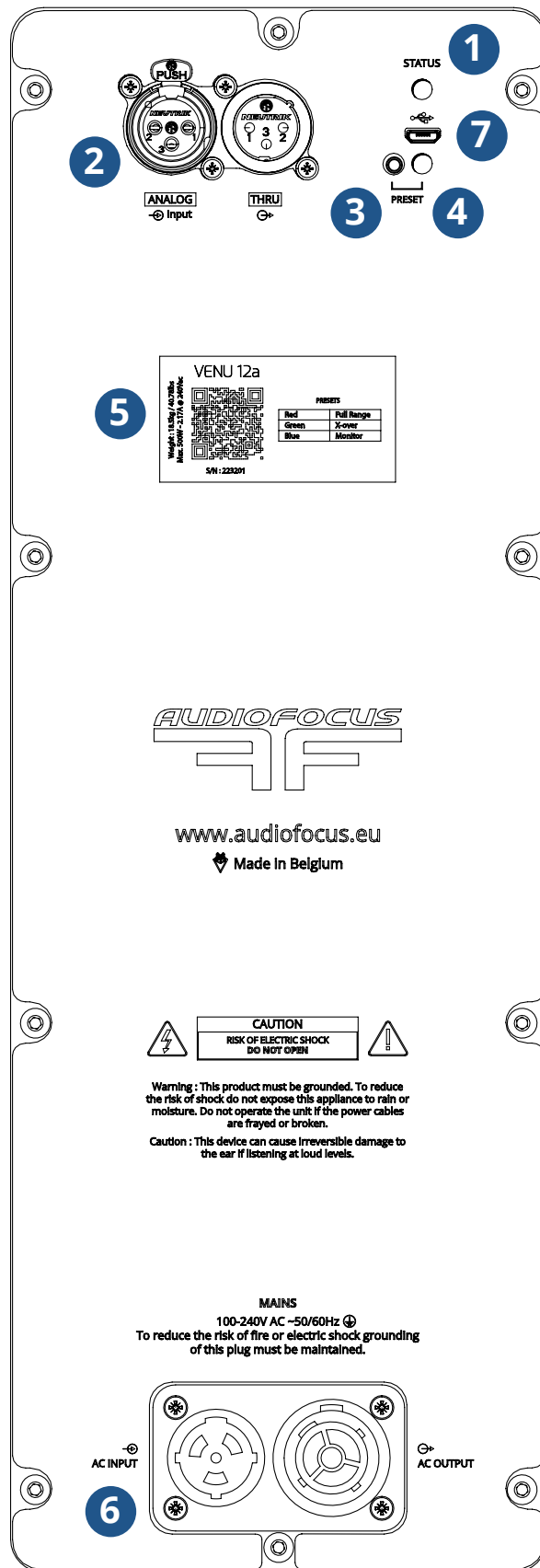

**Amplifiers can reach temperatures as high as 70°C.**

## 4.2 User interface



## Presets color scheme

Preset	Color	Description
Full Range 	Red	The standard preset, for a standalone system
X-over 	Green	Same curve as the Full Range but with a HP filter at 80 Hz to be used with an additional sub.
Monitor 	Blue	Same curve as the Full Range preset, but with a compensation EQ to reduce the floor coupling effect.

1. Status LED
  - solid Green for OK Status
  - blinking Green in start up mode
  - Red for temp warning or limit.
2. XLR 3-point IN and THRU
3. Preset switch. Press and hold until LED starts blinking. While blinking, toggle between presets. After a few seconds the preset is loaded and the LED glows solid.
4. Preset type indicator LED
5. Serial Number
6. PowerCON TRUE1 and powerCON TRUE1 link
7. Micro USB connector for factory preset updates.

## 5. BI-AMP & X- VERSION SETUP

---

### 5.1 Amplifier configuration

All AUDIOFOCUS cabinets can be powered by any of the AUDIOFOCUS A Series rack amplifiers with integrated DSP. Each preset includes all crossover, frequency and phase response correction, along with RMS and peak protection on each channel to protect the speaker from damage or misuse. AUDIOFOCUS can also supply Powersoft Armonia presets on request.

#### AUDIOFOCUS A Series Amplification Chart

Product	Channels Used	A-354 #Per circuit	A-354 #Per amp	A-704 #Per circuit	A-704 #Per amp	A-1504 #Per circuit	A-1504 #Per amp	A-3004 #Per circuit	A-3004 #Per amp
VENU 8X	1	1	4	2	8	4	16	4	16
VENU 12X	1	0	0	1	4	2	8	4	16
VENU 15X	1	0	0	1	4	2	8	4	16
VENU 12	2	0	0	2	4	2	4	4	8
VENU 15	2	0	0	2	4	2	4	4	8

Combinations of different speakers and / or subs are also possible.  
Please check the sub series amplification chart from the sub series manual.



## NL4 Connector detail Bi-amp Version

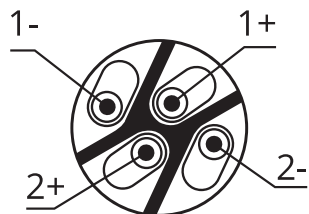

HF: +2 / -2  
LF: +1 / -1

NL4	Speaker	Polarity
1+	LF	+
1-	LF	-
2+	HF	+
2-	HF	-

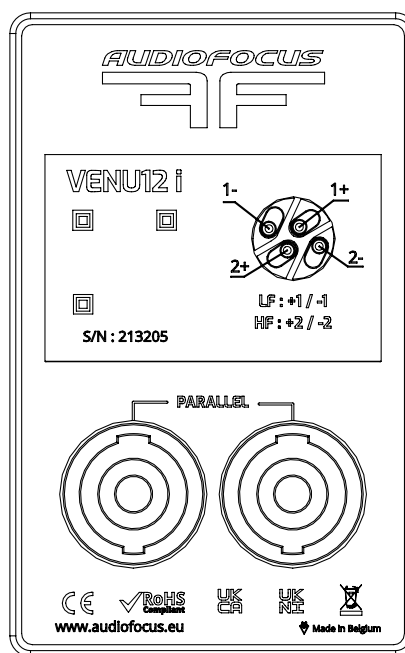
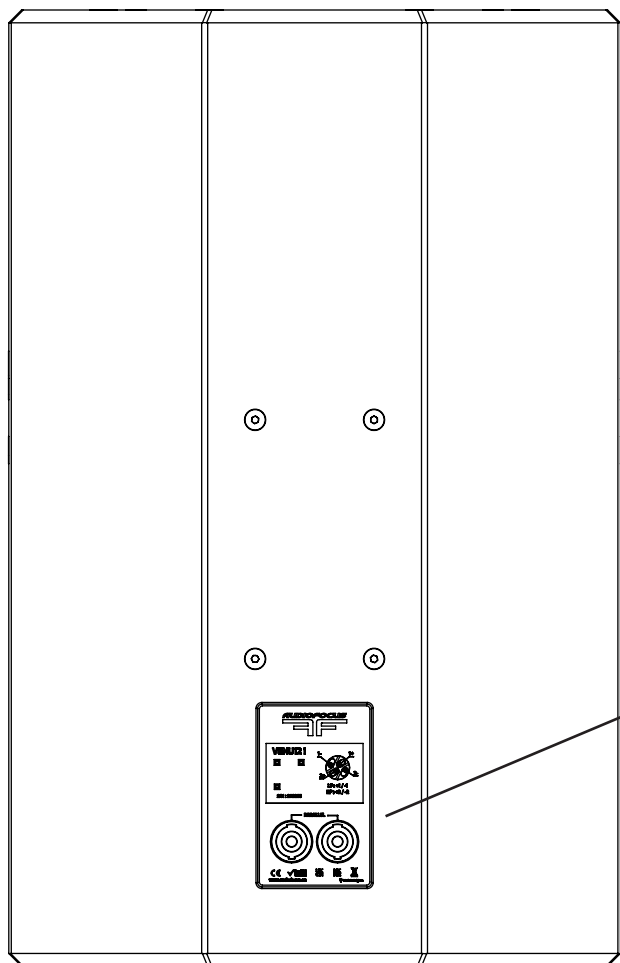

## NL4 Connector detail X-amp Version

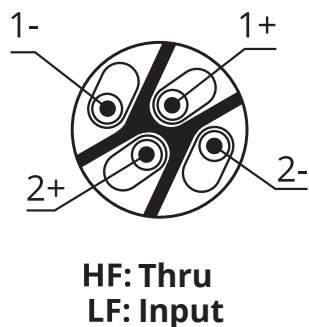

NL4	Speaker	Polarity
1+	Input	+
1-	Input	-
2+	Thru	+
2-	Thru	-

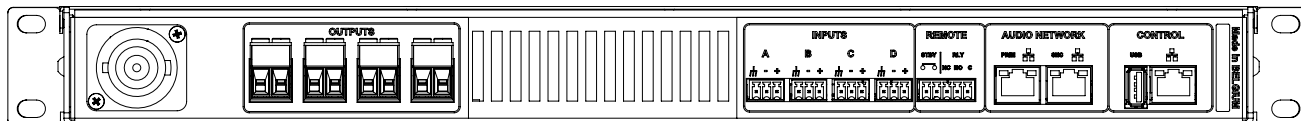
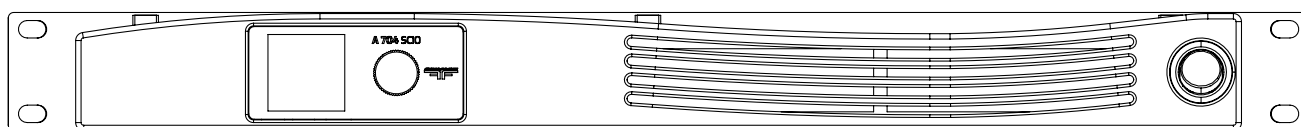

KIT en rendu:

KIT A - 1 amp, 4 x 4 VENU

KIT B - 2 amps, 2 x VENU Top, 2 x S 15 sub, 4 x 3 VENU monitor

KIT C - 3 amps 2 x VENU top, 2 x S 15 sub, 6 x 4 VENU monitor (2 per 2)



**Make sure to load the appropriate preset! Loading the wrong preset could damage the speakers.**

## 5.2 Connections

AUDIOFOCUS power and signal cables with the appropriate diameter, length and connectors are recommended. OPERATING VOLTAGE must always be between 90 and 264V. The power supply will auto switch to 110V or 230V, allowing the device to be used internationally without additional settings.



**AC POWER DISTRIBUTION must be properly grounded and on the same network for the entire sound system. POWER DISTRIBUTION must be well balanced.**

On a TETRA installation, each line (1, 2 and 3) will power the same number of devices. Each device will be powered between a line and neutral and all devices will be connected to the same ground.

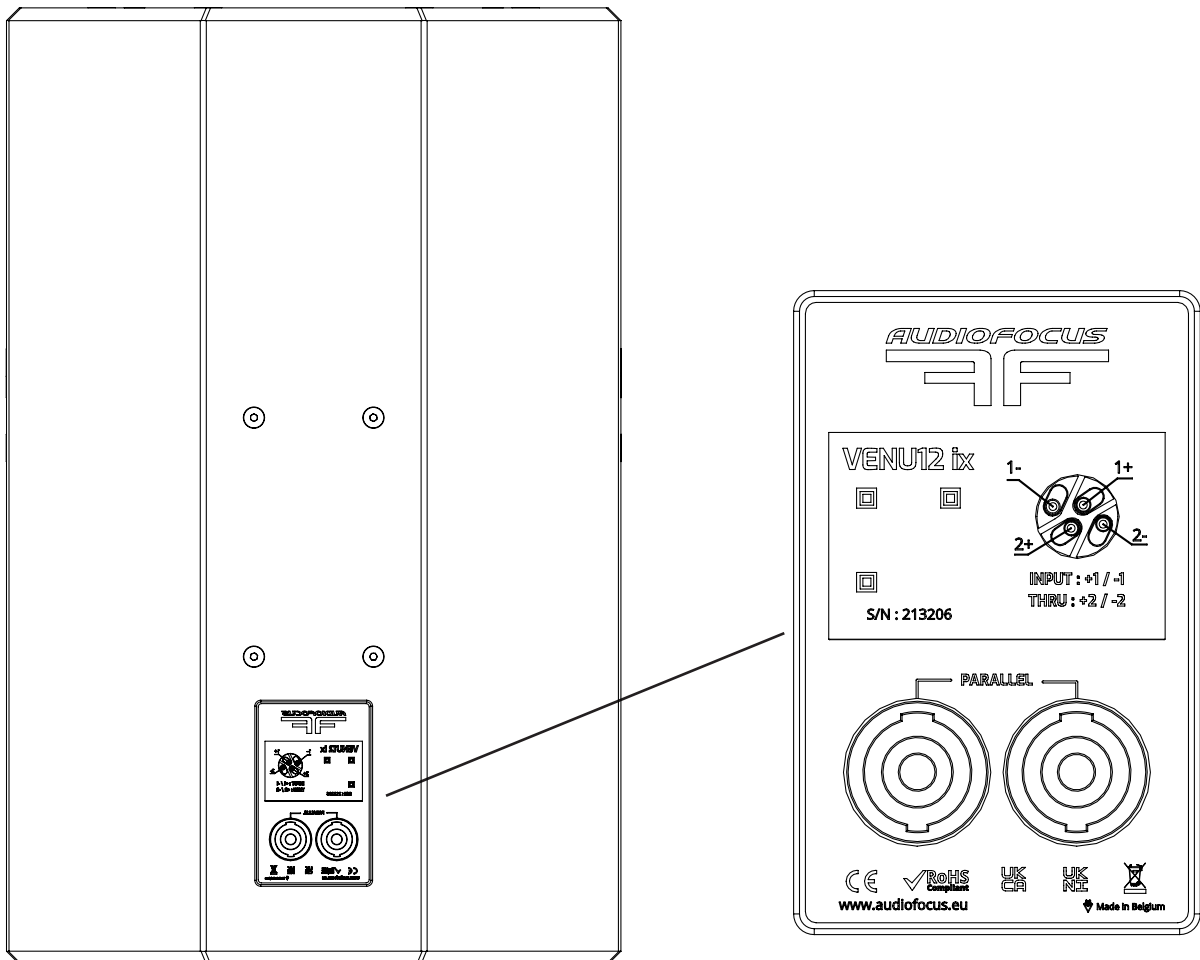

If you are not using an official AUDIOFOCUS cable kit, make sure to use the appropriate cable diameter and check the connection scheme.

## 5.3 Preset handling

Venu series presets are available for both Audiofocus A-series and Powersoft amplifiers.

Please refer to the corresponding Audiofocus Scio or Powersoft Armonia manual for more details regarding preset loading and operation.

## 6. USER GUIDELINES

---

### 6.1 Stacking and rigging



All local and national regulations should be complied with.  
Refer to qualified technicians for rigging and deployment.  
Only use original AUDIOFOCUS parts for rigging.  
Chain hoists and any other third-party devices should be rated to match the weight of the system and cables.  
Long term installations should be inspected regularly.

#### 6.1.1 Stacking

VENU series speakers can be used stacked or pole mounted.

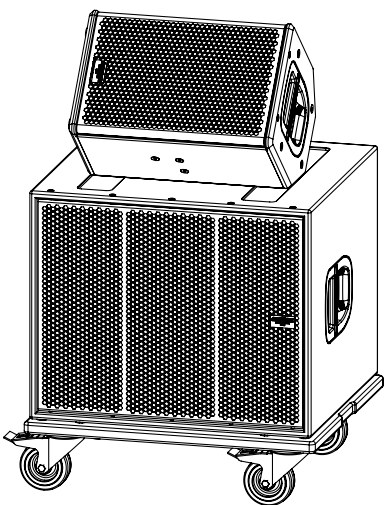

VENU stacked on S15 as monitor

VENU Stacked in front fill on 2 MTSUB218

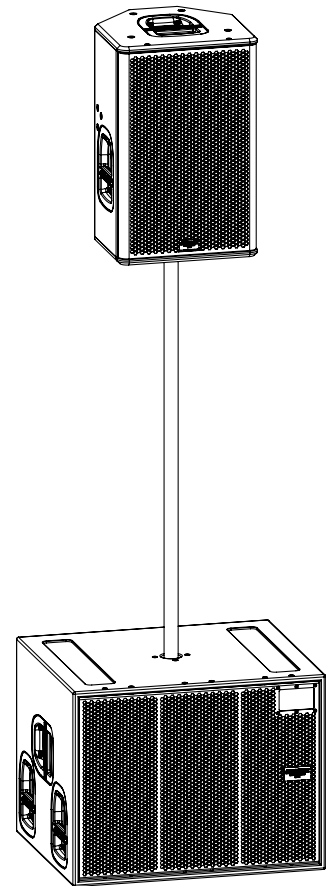

VENU pole mounted on S15

VENU series speakers are equipped with an adjustable angle speaker stand socket, allowing you to change the vertical angle of the cabinet. Angle adjustable up to +/- 13.05° in 4.5° steps



VENU on speaker stand



VENU on speaker stand with adjustable tilt angle base



Adjustable tilt angle base

## 6.1.2 Rigging

For information about rigging the install version, please refer to VENU install rigging manual.

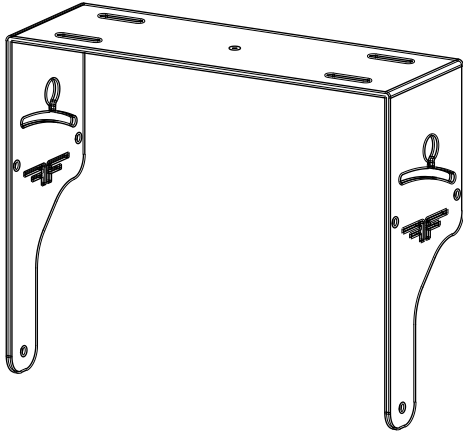

VENU Horizontal bracket



VENU eye bolt



## 6.2 Maintenance

VENU series speakers are protected by a Polyurea coating with a UV treatment to ensure extended system life and high shock resistance.

All speaker protection systems mentioned earlier will ensure an extended life.

If the cover becomes wet, remove it and allow it to dry. If cleaning is required, do not use aggressive cleaning products on synthetic parts.

Regularly check the condition of the cabinet.

Polyurea parts can be cleaned with furniture maintenance products. Metal parts can be cleaned with a microfiber cloth.



## 7. TECHNICAL SPECIFICATIONS

---

### 7.1 VENU 8a

#### **Type**

2-way active full-range point source  
(self-powered version only)

#### **Drivers**

LF: 1x8"

HF: 1x1"

#### **Frequency range -6dB**

55Hz-20kHz

#### **Power handling Watt AES/Peak, active and install version**

LF: 350/1400W

HF: 80/320W

#### **Nominal Impedance, active and install version**

8ohm

Passive cross-over network

#### **SPL Peak @ 1m pink noise Crest factor 5dB**

134 dBSPL

#### **Presets**

Dedicated AUDIOFOCUS and Armonia/Powersoft omni and cardio presets

#### **Self-powered audio Connectors**

IN: 1x3-point XLR

LINK: 1x3-point XLR

#### **Bi-amp connector**

2x SPK4 speakON

#### **Self-powered power Connectors**

IN: 1x3-point powerCON TRUE1

LINK: 1x3-point powerCON TRUE1

#### **Dimensions (h x w x d)**

430 x 275 x 290 mm / 16,77x10,82x11,41inches

#### **Weight following version**

Self-powered: 11,5kg / 25,35lbs

Passive: 10,1kg / 22,26lbs

#### **Finish**

Highly resistant polyurea coating

#### **Material**

First grade birch plywood 15 & 24 mm

## VENU 8 Horizontal beamwidth

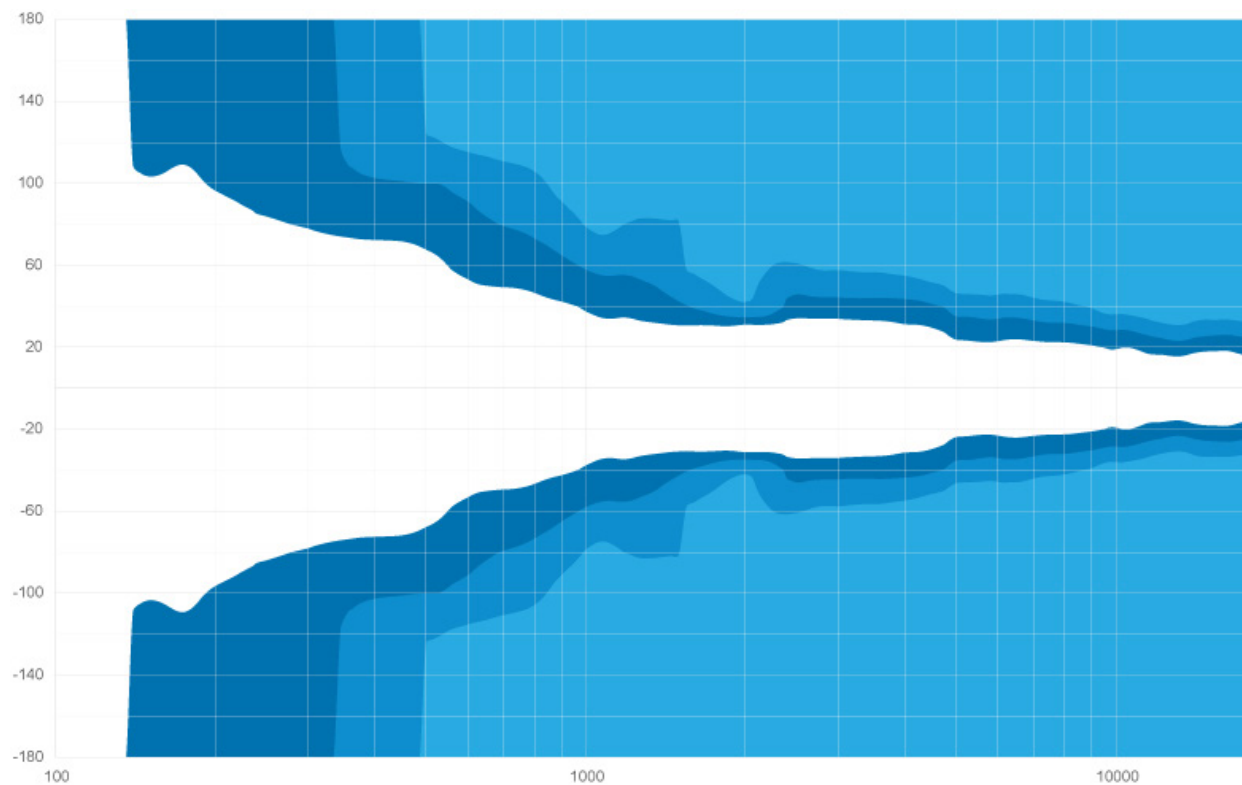

## VENU 8 Vertical beamwidth

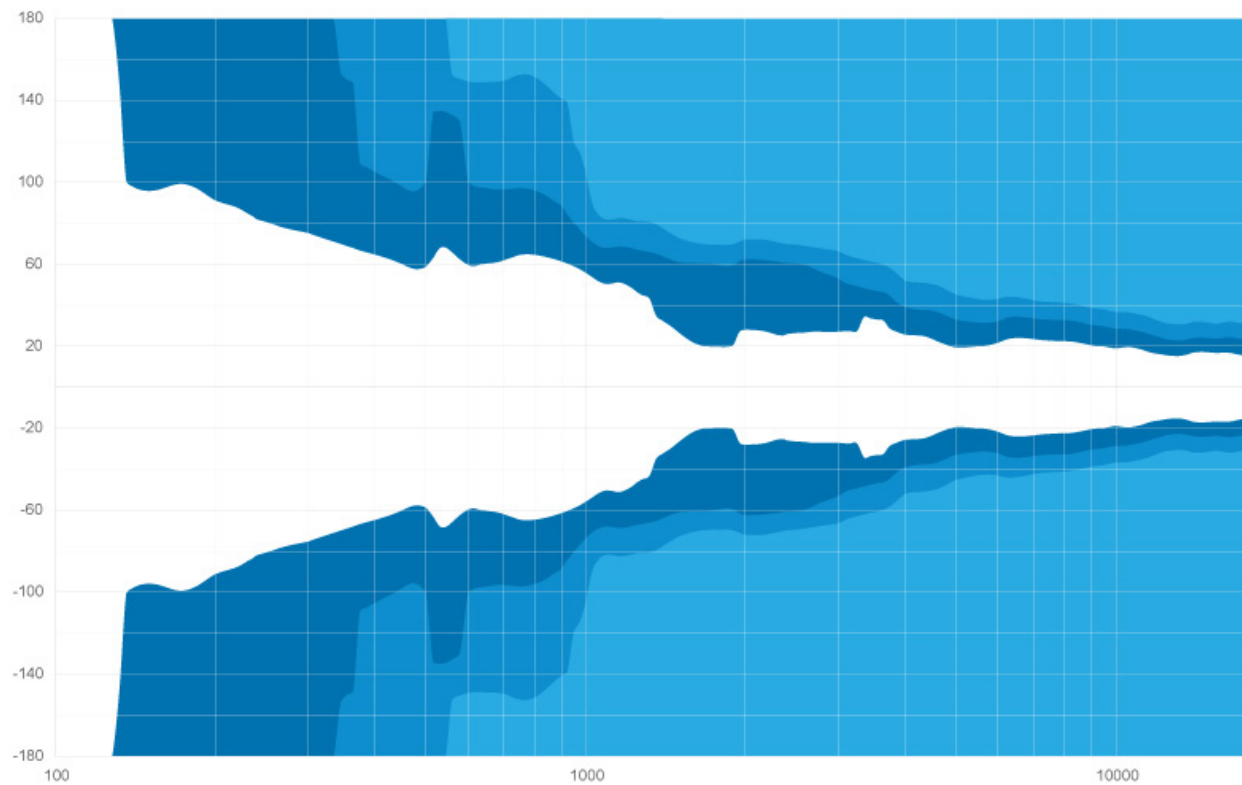

## 7.2 VENU 12a

### **Type**

2-way active full-range point source  
(self-powered version only)

### **Drivers**

LF: 1x12"

HF: 1x1"

### **Frequency range -6dB**

50Hz-20kHz

### **Power handling Watt RMS/Peak, active and install version**

LF: 350/1400W

HF: 35/140W

### **Nominal Impedance, active and install version**

8ohm

Passive cross-over network

### **SPL Peak @ 1m pink noise Crest factor 5dB**

135 dB

### **Presets**

Dedicated AUDIOFOCUS A-series SCiO and Powersoft Armonia presets

### **Self-powered audio Connectors**

IN: 1x3-point XLR

LINK: 1x3-point XLR

### **Bi-amp connector**

2x SPK4 speakON

### **Self-powered power Connectors**

IN: 1x3-point powerCON TRUE1

LINK: 1x3-point powerCON TRUE1

### **Dimensions (h x w x d)**

566 x 362 x 357 mm • 22.28 x 14.25 x 14.05 inches

### **Weight following version**

Self-powered: 18.5kg / 40.78lbs

Passive: 17.3kg / 38.13lbs

### **Finish**

Highly resistant polyurea coating

### **Material**

First grade birch plywood 15 & 24 mm

## VENU 12 Horizontal beamwidth

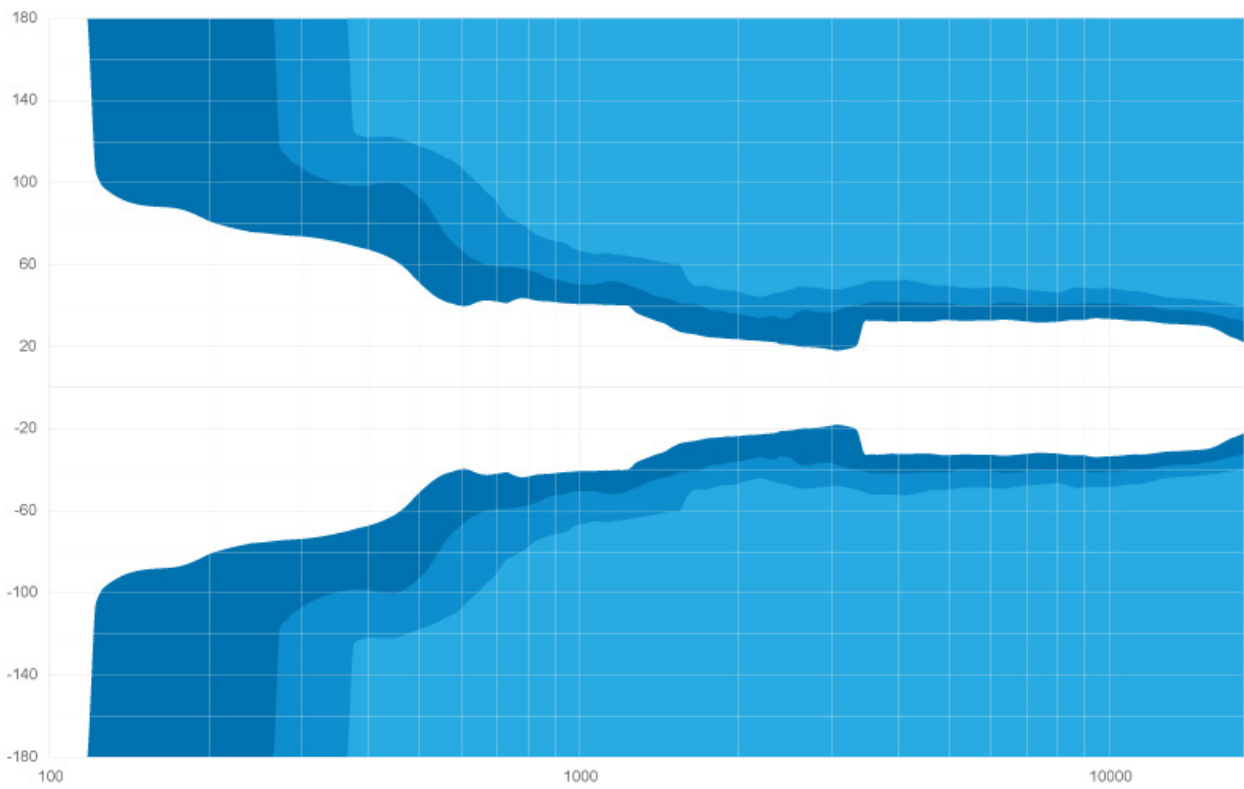

## VENU 12 Vertical beamwidth

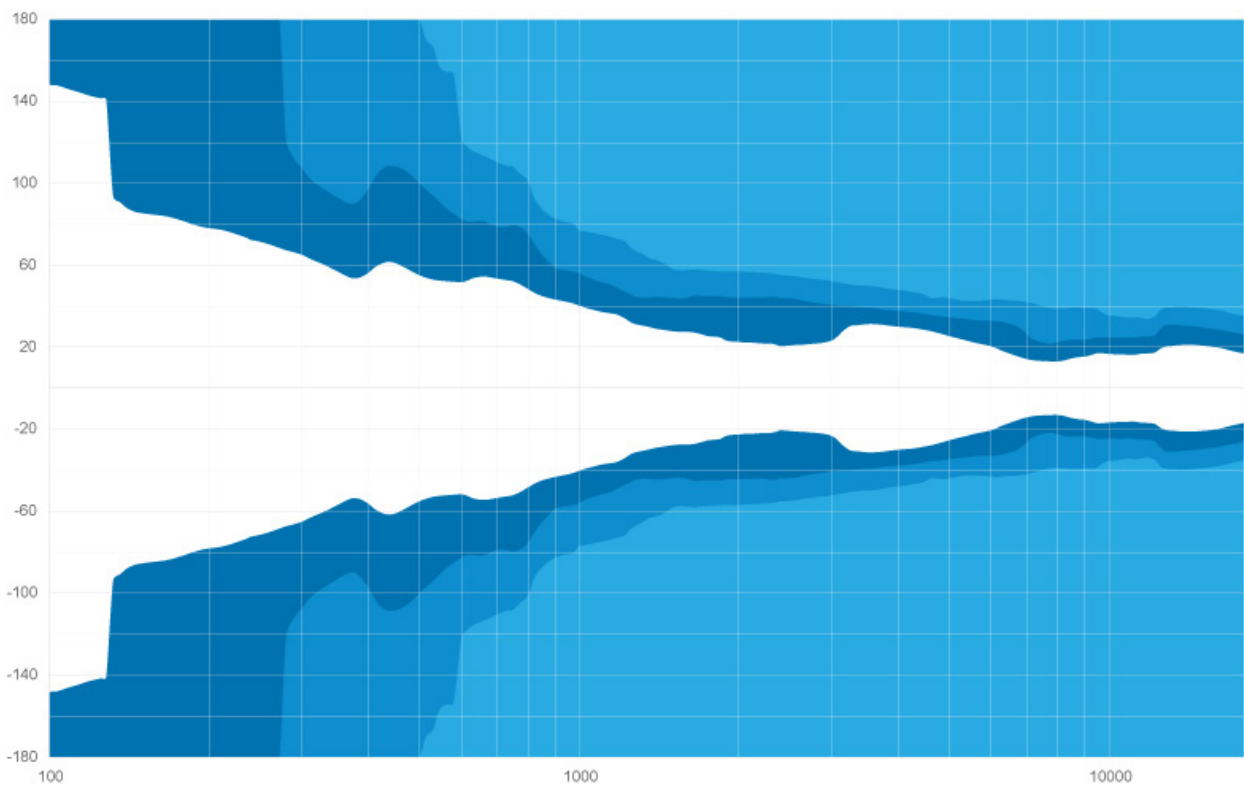

## 7.3 VENU 15a

### **Type**

2-way active full-range point source  
(self-powered version only)

### **Drivers**

LF: 1x15"

HF: 1x1"

### **Frequency range -6dB**

47Hz-20kHz

### **Power handling Watt RMS/Peak, active and install version**

LF: 400/1600W

HF: 35/140W

### **Nominal Impedance, active and install version**

8ohm

Passive cross-over network

### **SPL Peak @ 1m pink noise Crest factor 5dB**

136 dB

### **Presets**

Dedicated AUDIOFOCUS A-series SCiO and Powersoft Armonia presets

### **Self-powered audio Connectors**

IN: 1x3-point XLR

LINK: 1x3-point XLR

### **Bi-amp connector**

2x SPK4 speakON

### **Self-powered power Connectors**

IN: 1x3-point powerCON TRUE1

LINK: 1x3-point powerCON TRUE1

### **Dimensions (h x w x d)**

638 x 426 x 412 mm • 25.11 x 16.77 x 16.22 inches

### **Weight following version**

Self-powered: 22.5kg / 49.60lbs

Passive: 17.3kg / 38.13lbs

### **Finish**

Highly resistant polyurea coating

### **Material**

First grade birch plywood 15 & 24 mm



## VENU 15 Horizontal beamwidth

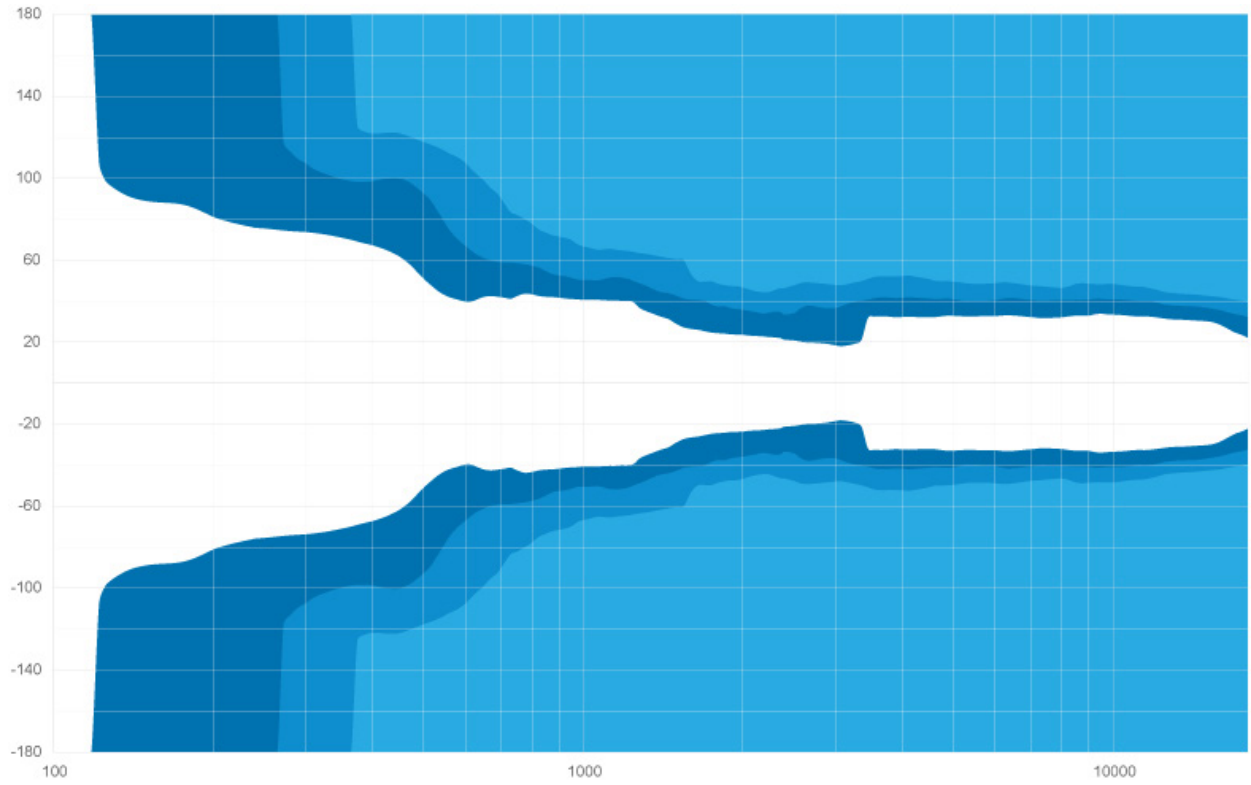

## VENU 15 Vertical beamwidth

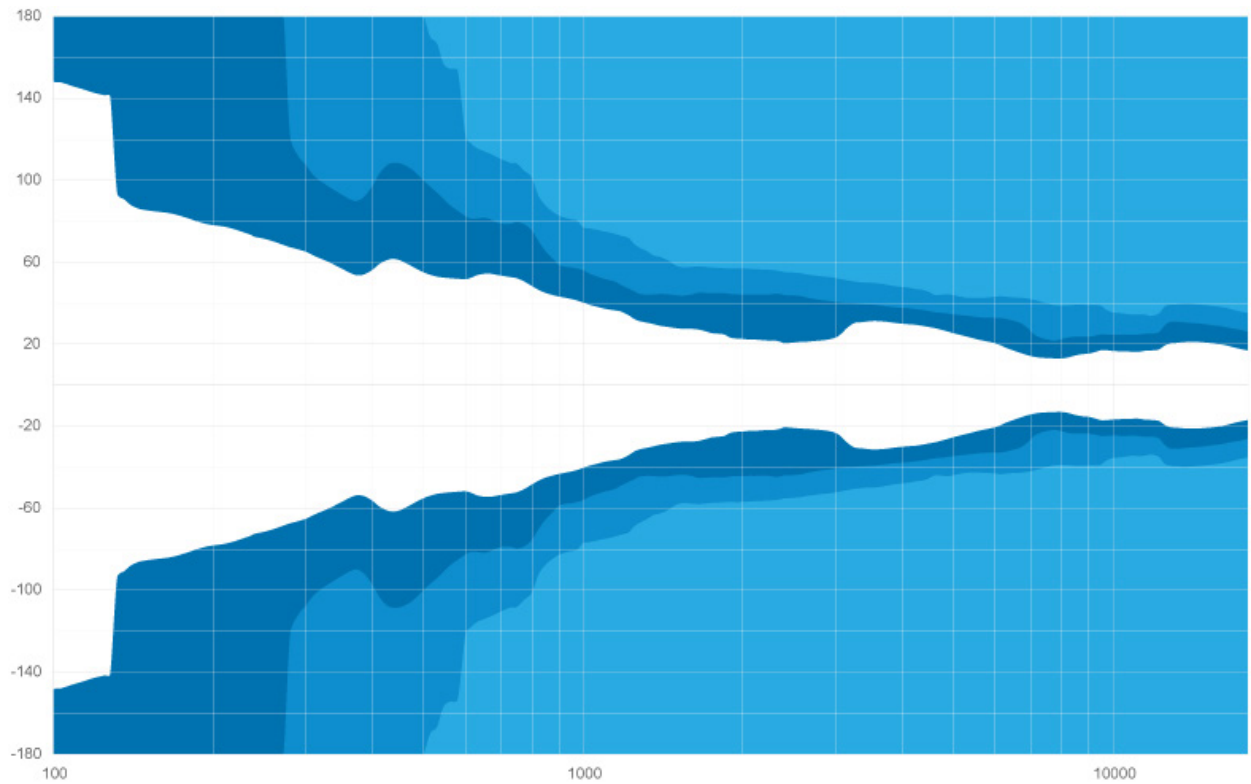

## 8. CONTACT AND LINKS

---

**Need more informations about our products ?**

[www.audiofocus.eu](http://www.audiofocus.eu)

[info@audiofocus.eu](mailto:info@audiofocus.eu)

[www.facebook.com/AudiofocusPage/](https://www.facebook.com/AudiofocusPage/)

[www.facebook.com/groups/AUDIOFOCUS/](https://www.facebook.com/groups/AUDIOFOCUS/)

**Scan QR Code to view the AUDIOFOCUS website.**



**Follow Us.**

